

# Free Standing Acrylic Bathtub Installation Instructions

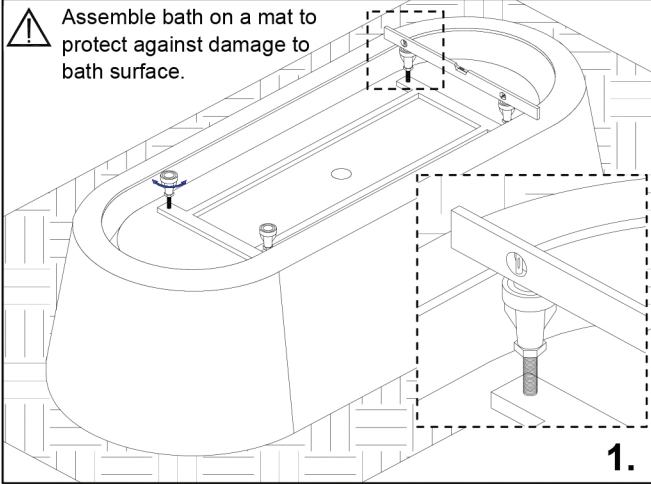

- Ensure legs are adjusted in line with the base of bath.

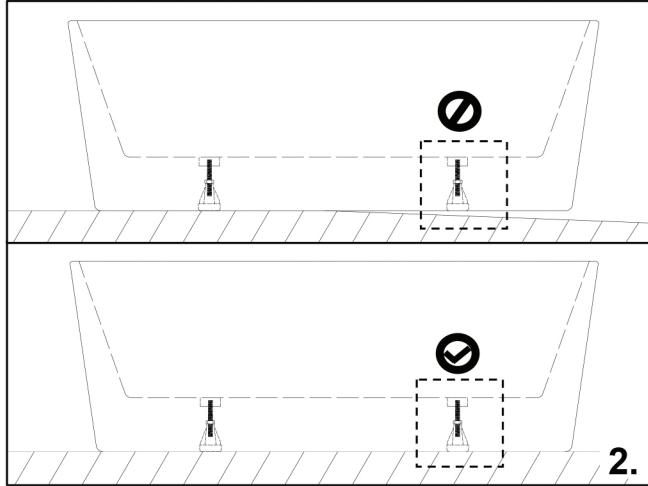

- Check that bath sits flat; if required adjust legs to compensate for floor level.

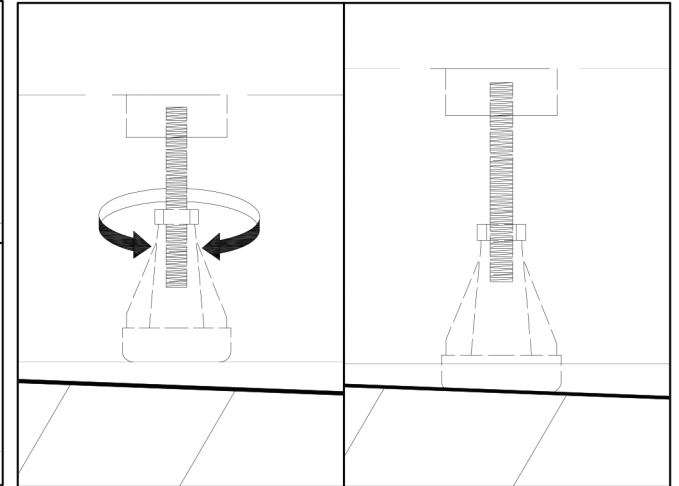

- Before step 3 set waste connection in position.

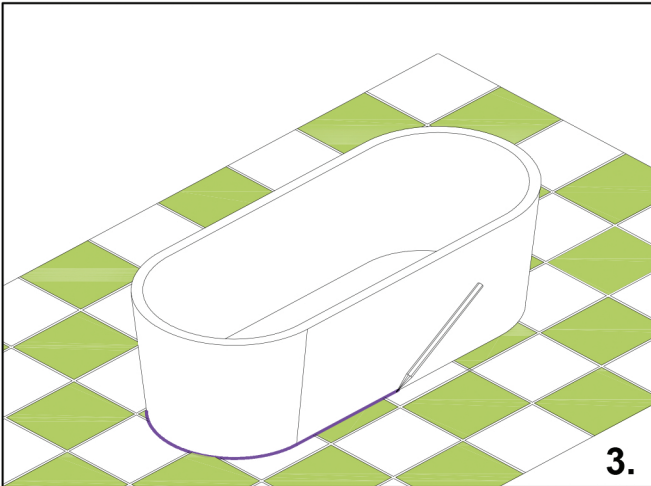

- With pencil trace outline of bath.

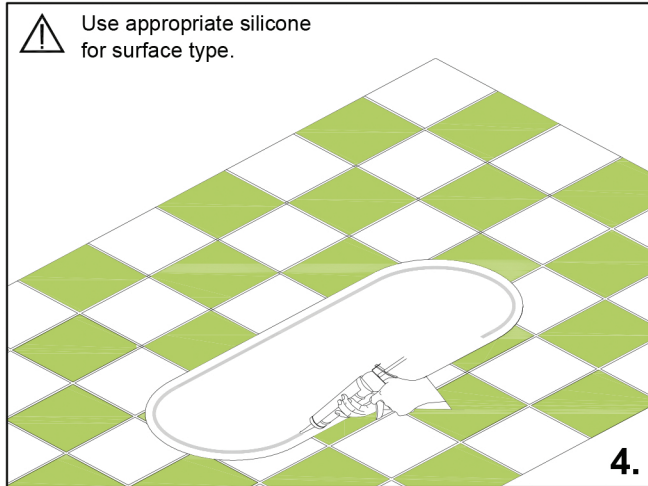

- Apply a thick bead of silicone within bath outline.

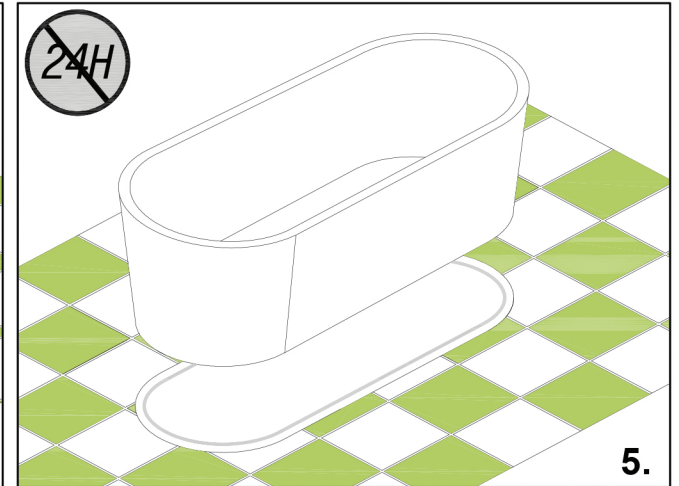

- Set bath in final position.

 This installation guide does not include details of waste connection; final decision about installation of waste connection should be taken by a suitably qualified person.

# Free Standing Acrylic Bathtub Installation Instructions

Option1

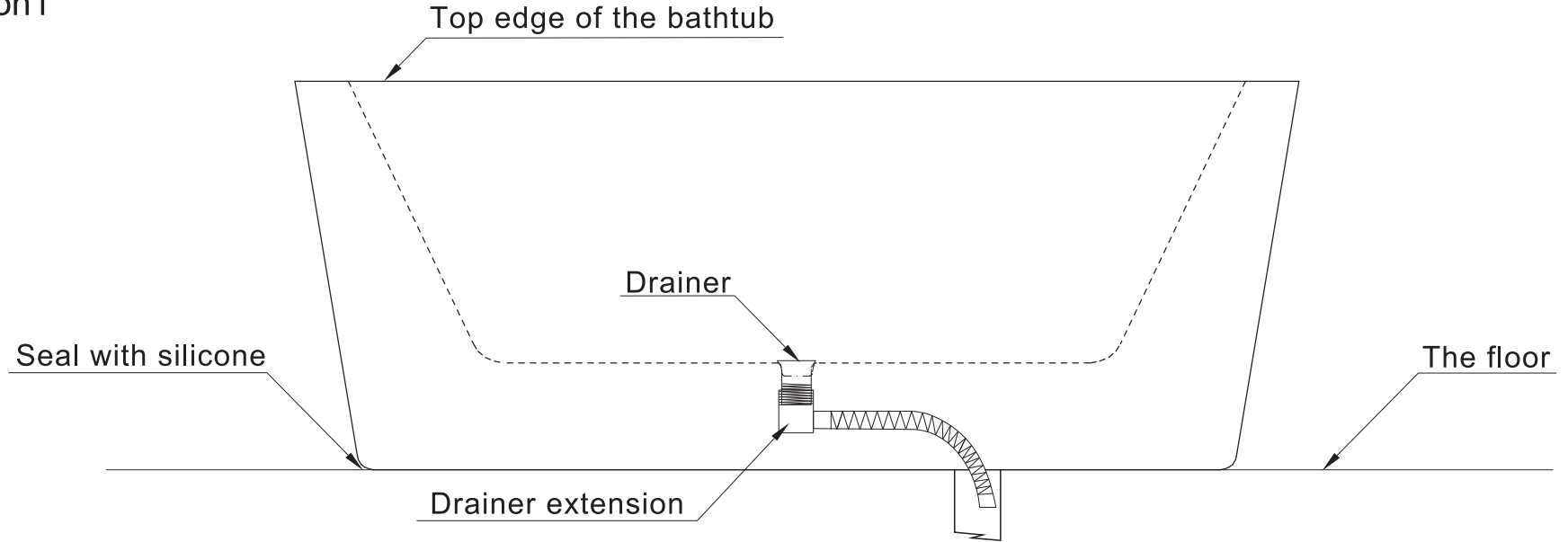

Option2

